



RAPID CONTROL SERVICE, INC.

Partners In Automation Since 1964

PNEUMATIC / ELECTRICAL / RESISTANCE WELDING

Phone: 616-538-1111

WATTS: 1-800-632-1857

Fax: 616-538-6847

Website: www.rapidcontrol.com

E-Mail: sales@rapidcontrol.com

M8 Pico Cables

M12 Micro Cables

Weld Cell Cables



2479 28th Street SW • Grand Rapids • MI • 49519



RAPID CONTROL SERVICE, INC.

Partners In Automation Since 1964

PNEUMATIC / ELECTRICAL / RESISTANCE WELDING

Phone: 616-538-1111

WATTS: 1-800-632-1857

Fax: 616-538-6847

Website: www.rapidcontrol.com

E-Mail: sales@rapidcontrol.com

C Series - M8 Pico Cables

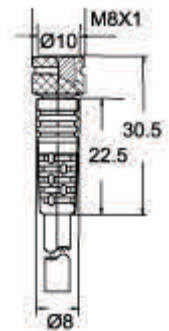

C Series Specifications:	
Connection	M8
Application Class	HNE acc. to DIN 40040 (-25°C / +90°C/ 75% RH)
Pin Material	Gold-plated Brass
Molded Body	PVC, TPU, self-extinguishing
O-ring	Vi ton
Threaded Connector	Nickel-plated Brass
Operating Voltage	300 VDC
Nominal Power	4A
Nominal Voltage	60VAC/75VDC (10-30 VDC for LED models)
Test Voltage	1.5 KV eff./60s
Insulation	Insulation Group: C acc. to VDE 0110, Insulation Resistance: >109
Protection	IP67 (IP65 for snap-in models)

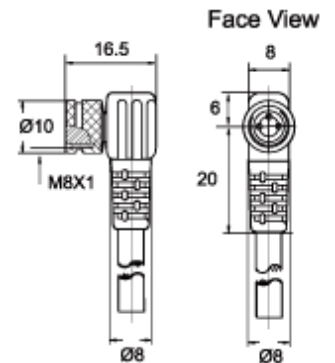

3 Pin

Female

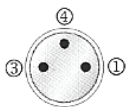

Male

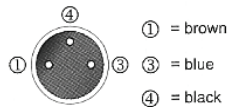

Straight	Female	C-FS3TZ-V075
Straight	Male	C-MS3TZ-V075
90°	Female	C-FA3TZ-V075
90°	Male	C-MA3TZ-V075

4 Pin

Female

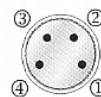

Male

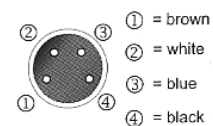

Straight	Female	C-FS4TZ-V075
Straight	Male	C-MS4TZ-V075
90°	Female	C-FA4TZ-V075
90°	Male	C-MA4TZ-V075



RAPID CONTROL SERVICE, INC.

Partners In Automation Since 1964

PNEUMATIC / ELECTRICAL / RESISTANCE WELDING

Phone: 616-538-1111

WATTS: 1-800-632-1857

Fax: 616-538-6847

Website: www.rapidcontrol.com

E-Mail: sales@rapidcontrol.com

R Series - M12 DC Micro Cables



R Series Specifications:	
Connection	M12
Application Class	HNE acc. to DIN 40040 (-25°C / +90°C / 75% RH)
Pin Material	Gold-plated Brass
Molded Body	PVC, TPU, self-extinguishing
O-ring	Vi ton
Threaded Connector	Nickel-plated Brass
Operating Voltage	300 VDC
Nominal Power	4A (CSA=3A)
Nominal Voltage	250VAC/300VDC (10-30 VDC for LED models)
Test Voltage	2.0 KV eff./60s
Insulation	Insulation Group: C acc. to VDE 0110, Insulation Resistance: >109
Protection	IP68

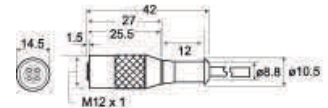

Female

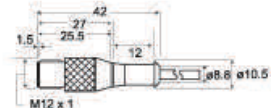

Male

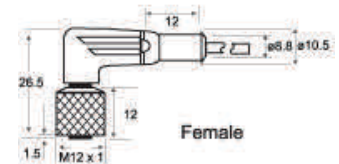

Female

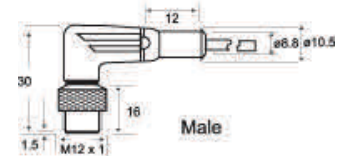

Male

3 Pin

Female



Male

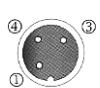

- ① = brown
- ③ = blue
- ④ = black

Straight	Female	R-FS43TZ-V075
Straight	Male	R-MS43TZ-V075
90°	Female	R-FA43TZ-V075
90°	Male	R-MA43TZ-V075

4 Pin

Female



Male

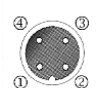

- ① = brown
- ② = white or not used
- ③ = blue
- ④ = black

Straight	Female	R-FS4TZ-V075
Straight	Male	R-MS4TZ-V075
90°	Female	R-FA4TZ-V075
90°	Male	R-MA4TZ-V075

5 Pin

Female



Male



- ① = brown
- ② = white
- ③ = blue
- ④ = black
- ⑤ = green/yellow

Straight	Female	R-FS5TZ-V025
Straight	Male	R-MS5TZ-V025
90°	Female	R-FA5TZ-V025
90°	Male	R-MA5TZ-V025



RAPID CONTROL SERVICE, INC.

Partners In Automation Since 1964

PNEUMATIC / ELECTRICAL / RESISTANCE WELDING

Phone: 616-538-1111

WATTS: 1-800-632-1857

Fax: 616-538-6847

Website: www.rapidcontrol.com

E-Mail: sales@rapidcontrol.com



Double-Ended Cables for Weld Cells

TPE cables with PTFE coated nuts and factory

R-MS4TZ-T070.6+R-FS4/3TP-T070.6-S

M8

Part Number	Description	Price
C-MS3TZ-T070.3+C-FS3TZ-T070.3-S	M8 Male Straight to M8 Female 3-pin TPE with Silicone Protection 0.3M Length	\$26.00
C-MS3TZ-T070.6+C-FS3TZ-T070.6-S	M8 Male Straight to M8 Female 3-pin TPE with Silicone Protection 0.6M Length	\$26.00
C-MS3TZ-T071+C-FS3TZ-T071-S	M8 Male Straight to M8 Female 3-pin TPE with Silicone Protection 1M Length	\$30.00
C-MS3TZ-T072+C-FS3TZ-T072-S	M8 Male Straight to M8 Female 3-pin TPE with Silicone Protection 2M Length	\$30.00
C-MS3TZ-T075+C-FS3TZ-T075-S	M8 Male Straight to M8 Female 3-pin TPE with Silicone Protection 5M Length	\$40.00

M12

R-MS4TZ-T070.3+R-FS4/3TP-T070.3-S	M12 Male Straight to M12 Female Straight 4-pin TPE with Silicone Protection & LED .03M Length	\$26.00
R-MS4TZ-T070.6+R-FS4/3TP-T070.6-S	M12 Male Straight to M12 Female Straight 4-pin TPE with Silicone Protection & LED .06M Length	\$26.00
R-MS4TZ-T071+R-FS4/3TP-T071-S	M12 Male Straight to M12 Female Straight 4-pin TPE with Silicone Protection & LED 1M Length	\$28.00
R-MS4TZ-T072+R-FS4/3TP-T072-S	M12 Male Straight to M12 Female Straight 4-pin TPE with Silicone Protection & LED 2M Length	\$30.00
R-MS4TZ-T075+R-FS4/3TP-T075-S	M12 Male Straight to M12 Female Straight 4-pin TPE with Silicone Protection & LED 5M Length	\$40.00

2479 28th Street SW • Grand Rapids • MI • 49519